

HYUNDAI
POWER PRODUCTS

DIESEL GENERATOR DHY12500SE

User manual

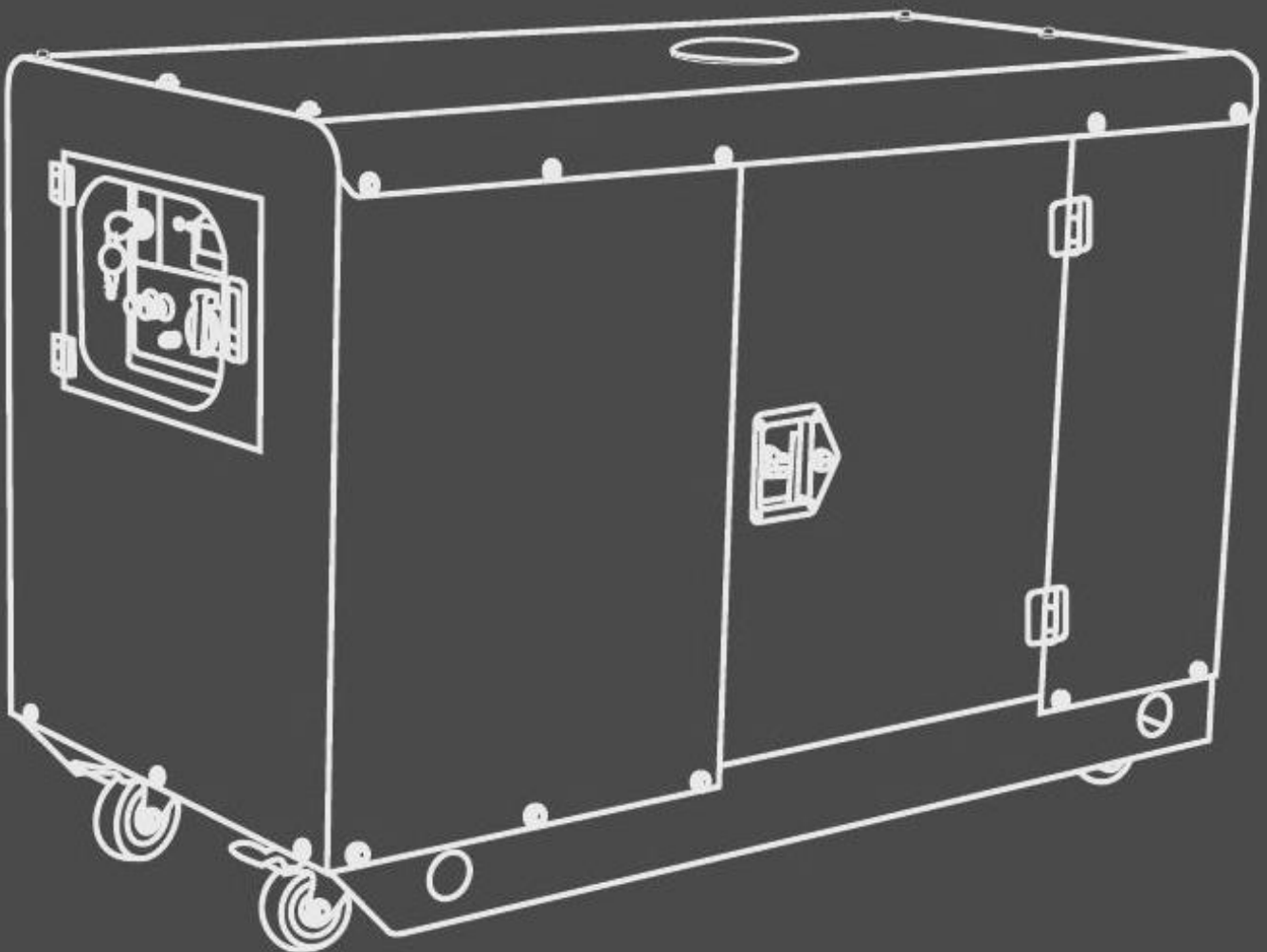

CONTENTS

Section Description	Page N°/N°s
1. SAFETY	4 - 7
2. CHECKS BEFORE USE	8 - 10
3. OPERATION	11
4. MAINTENANCE	12 - 13
5. TROUBLESHOOTING	14
6. SPECIFICATIONS	15
7. WIRING DIAGRAM	16
8. STORAGE & TRANSPORTATION	17
9. PART LOCATIONS	18 - 19
10. DECLARATIONS of CONFORMITY	20
11. RECYCLING & PRODUCT DISPOSAL	21
12. CONTACT DETAILS	21
13. MANUAL UPDATES	21
14. WARRANTY	21

1. SAFETY

1.1. General safety notes.

1.1.1. The operator of the machine is responsible for, and has a duty of care in making sure that the machine is operated safely and in accordance with the instructions in this user manual. Keep the manual safe and pass it on if the machine is loaned or sold to another user.

1.1.2. Please note the following safety points.

1.1.2.1. The machine should never be left in a condition which would allow an untrained or unauthorised person/s to operate this machine.

1.1.2.1.1. All due care and diligence should be taken by the operator for the safety of, and with regard to those around whilst using the machine.

1.1.2.1.2. Some or all of the following - warning signs, symbols and/or PPE pictograms may appear throughout this manual. You MUST adhere to their warning/s. Failure to do so may result in personal injury to yourself or those around you.

DANGER

Indicates a hazard, which, if not avoided, could result in serious injury or death.

WARNING

Indicates a hazard, which, if not avoided, could result in serious injury.

CAUTION

Indicates a hazard which, if not avoided, might result in minor or moderate injury.

NOTE

Indicates a situation that could easily result in equipment damage.



READ and keep the manual safe and pass it on if the machine is loaned or sold to another user. You MUST fully read instructions to make sure you use and operate machine safely.

Appropriate Personal Protective Equipment (PPE), MUST be worn at all times when machine is in use or being repaired.



1.2. Carbon monoxide.

1.2.1. Carbon monoxide is a colourless and odourless gas. Inhaling this gas can cause death as well as serious long term health problems such as brain damage.

1.2.2. The symptoms of carbon monoxide poisoning can include but are not limited to the following; Headaches, dizziness, nausea, breathlessness, collapsing or loss of consciousness.

1.2.2.1. Carbon monoxide poisoning symptoms are similar to flu, food poisoning, viral infections and simply tiredness. It is quite common for people to mistake this very dangerous poisoning for something else.

1.2.2.2. To avoid carbon monoxide poisoning DO NOT use Petrol/Diesel- powered equipment inside any of the following; Home, garage, tent, camper van, mobile home, caravan or boat.

This list is not exhaustive and if you are in any doubt contact your dealer.

1.2.3. If you think you have or someone around you has been affected by carbon monoxide poisoning;

1.2.3.1. Get them fresh air immediately, by leaving the affected area or by opening doors and windows. If safe and practical to do so make sure that the machine is turned off. DO NOT enter a room you suspect of having carbon monoxide present – instead call the emergency services.

1.2.3.2. Contact a doctor immediately or go to hospital - let them know that you suspect carbon monoxide poisoning.

1.2.4 DO NOT use in an enclosed area or a moving vehicle.

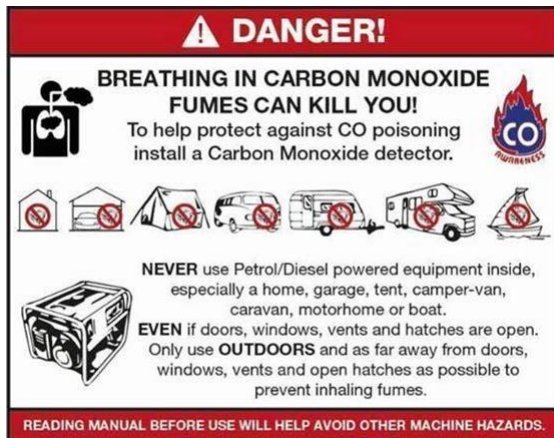

1.3. General fuel safety (where applicable).



ALL FUELS ARE FLAMMABLE

1.3.1. Fire hazard - keep fuel away from all sources of ignition for example heaters, lamps, sparks from grinding or welding.



Fire Hazard

1.3.2. DO NOT carry out hot work on tanks that have contained fuel it is extremely dangerous.

1.3.3. ALWAYS keep work area clean and tidy.

1.3.4. ALWAYS clean up all spills promptly using correct methods i.e. absorbent granules and a lidded bin.

1.3.5. ALWAYS dispose of waste fuels correctly.

1.4. Fuelling/De-fuelling (where applicable).



ALL FUELS ARE FLAMMABLE

1.4.1. ALWAYS fuel and defuel in a well-ventilated area outside of buildings.

1.4.2. ALWAYS wear correct, suitable and fit for purpose Personal Protective Equipment (PPE), suggested items are but not limited to safety gloves and overalls.



1.4.3. When fuelling/de-fuelling ALWAYS avoid inhaling fumes

1.4.4. When de-fuelling ALWAYS use a proprietary fuel retriever.

1.4.5. ALWAYS carry fuel in the correct and clearly marked container.



Fire Hazard

1.5. Electrical safety.



Risk of electric shock

1.5.1. Electricity can kill - NEVER work on LIVE/ENERGISED equipment.

1.5.2. Prior to carrying out any maintenance work you MUST Identify electrical isolation methods and isolate all electrical supplies,

1.5.3. Prior to use and with all electrical supplies isolated You MUST check all electrical cables, plugs and connections for the following;

1.5.3.1. Are intact and have no signs of damage, to include but not limited to bare wires, chaffing, cuts and loose wiring.

1.5.3.2. If there are any signs of damage, the damaged item MUST be taken out of service until the damage has been repaired by an electrically competent person.

1.5.3.3. All trailing cables should be routed so as not to cause any kind of trip hazard.

1.5.3.4. NEVER work on or near electricity with wet hands, wet clothing, and wet gloves.

1.6. Batteries.



Corrosive

1.6.1. Batteries present a risk if they become damaged by the possible leaking of electrolyte. This electrolyte is an acid and can cause serious burn injuries. Care should be taken when working on or near them. NOTE the electrolyte may be in liquid or gel form.

1.6.2. Should you come into contact with electrolyte you should;

1.6.2.1. Remove all clothing contaminated with electrolyte. If you cannot remove then saturate in water.

1.6.2.2. Get medical assistance as soon as possible. You must advise the medical staff of the type acid.

1.6.2.2.1. Lead/acid battery = dilute sulphuric acid

1.6.2.2.2. Nickel/cadmium = potassium hydroxide alkali electrolyte.

1.6.2.3. Use fresh running water to wash off excess electrolyte, continue this until medical assistance arrives. Make sure that you do not wash the electrolyte to another part of the face or body.

1.6.2.4. If electrolyte comes into contact with Eyes the electrolyte needs to be immediately washed away with large amounts of water. Make sure that you do not wash the electrolyte to another part of the face or body.

1.6.3. Gasses from charging batteries are highly flammable and great care should be taken to charge in well ventilated areas.

1.6.4. There is an explosion risk if the battery terminals are short circuited, when connecting/dis-connecting ALWAYS exercise great care so that the terminals or battery leads are NOT allowed to touch and cause a spark. ALWAYS use suitable insulated tools.



Risk of explosion

1.7. Vibrations (where applicable).

1.7.1. Prolonged use of hand held (operated) machines will cause the user to feel the effects of/from vibrations. These vibrations can lead to white finger (Raynaud's phenomenon) or carpal tunnel syndrome. This condition reduces the ability of the hand to feel and regulate temperature, causing numbness and heat sensations and may cause nerve damage and circulatory tissue death.

1.7.2. Not all factors that lead to white finger disease are known, but cold weather, smoking

and other diseases that affect blood vessels and blood circulation as well as large and long-lasting impact of shocks are considered factors in the formation of white finger. Note the following to reduce the risk the white finger and carpal tunnel syndrome:

1.7.2.1. Wear gloves and keep your hands warm

1.7.2.2. Take regular breaks

1.7.3. All of the above precautions may help reduce the risk of white finger disease but not rule out carpal tunnel syndrome. Long-term and regular users are therefore recommended to observe the condition of your hands and fingers. Seek medical attention immediately if any of the above symptoms should occur.

1.8. Noise (where applicable).

1.8.1. The operating noise of the machine can damage your hearing. Wear hearing protection such as earplugs or ear defenders to protect your hearing. Long-term and regular users are advised to have hearing checked regularly. Be especially vigilant and cautious when wearing hearing protection because your ability to hear alarm warnings will be reduced.

1.8.2. Noise emissions for this equipment is unavoidable. Carry out noisy work at approved times and for certain periods. Limit the working time to a minimum. For your personal protection and protection of people working nearby it is also advisable for them to wear hearing protection.

1.8.3. See CERTIFICATE of CONFORMITY section for Outdoor Noise declaration of conformity.



1.9. Additional safety instructions.

1.9.1. Carry out inspection before starting each time.

1.9.2. To prevent possible fires keep the generator set at least 1 metre from other objects. You must keep the generator away from all combustible materials.

- 1.9.3. Keep children and animals away from running generator set to prevent injuries.
- 1.9.4. Make sure that all operator of this machine are fully trained in the safe use and operation. DO NOT allow untrained persons to use or operate this machine.
- 1.9.5. Make sure when adding fuel that the work area is fully ventilated and that the machine has been shut down.
- 1.9.6. DO NOT overfill the fuel tank.
- 1.9.7. Make sure the fuel cap is screwed tightly.
- 1.9.8. You MUST clean up any fuel spillages before starting the generator.

1.9.9. Make sure there are no naked flames, cigarettes, fires and sparks where the generator is re-fuelled or fuel is stored.

1.9.10. You MUST operate the unit on level stable ground. The unit has locking wheels, which should be applied to prevent the machine moving during operation

1.9.11. The exhaust and engine will be very HOT during use and will remain HOT for some time after use. You MUST avoid touching the engine or exhaust while they are still hot. To avoid fire hazard you MUST store the engine after it has been allowed to cool down.

2. CHECKS BEFORE USE

2.1. Oil level.

NOTE

Running the engine with no oil will cause engine damage which will not be covered under warranty

2.1.1. You MUST check the oil level before each use.

2.1.2. To access oil filler cap and dipstick. You must open the left hand access door as viewed from control panel end.

2.1.3. Pull the dipstick upwards out of the engine block, wipe it clean then fully reinsert the dipstick remove it and check the level. The oil should leave a mark between the lower and upper levels. If the level is low you must top it up until it is closer to the upper level. DO NOT overfill with oil. Wipe up any excess oil.

2.1.4. From empty the machine can hold 2.25 litres of oil.

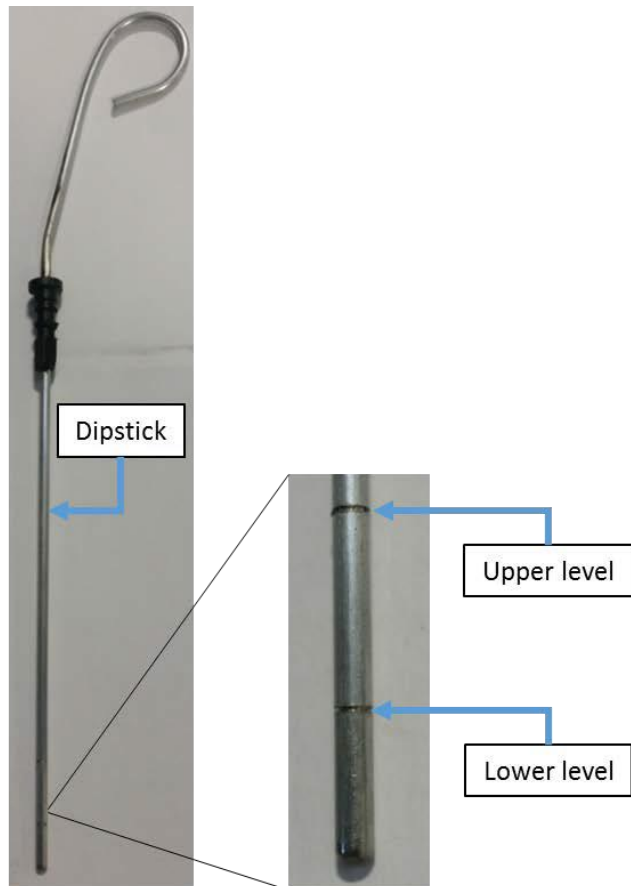
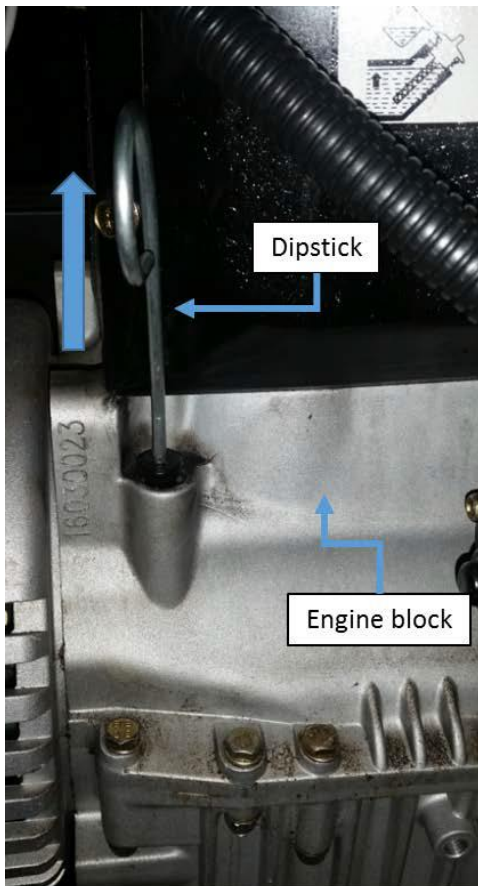

2.2. Fuel – This machine uses Diesel fuel only.

⚠ WARNING

You MUST stop the machine and allow it to cool down before filling with fuel. You must refuel in a well ventilated place and always from any sources of ignition, such as naked flames, sparks from grinders etc.

2.2.1 You must check the fuel level is sufficient for the machine to be used for the specific duration required.

2.2.2. There is simple fuel level gauge fitted to the fuel tank base.

2.2.3 To access the fuel gauge and fuel cap open the right hand door as viewed for the control panel end.

2.2.4. To fill with fuel undo the fuel filler cap and either fill or top up with fresh diesel.

2.2.5. DO NOT over fill with fuel – fill the fuel tank to the level indicated in picture below. Clean up any fuel spillages before starting the machine.

2.2.6. From empty the machine can hold 60 litres of diesel fuel.

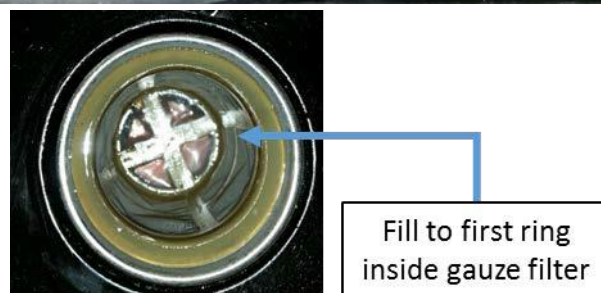
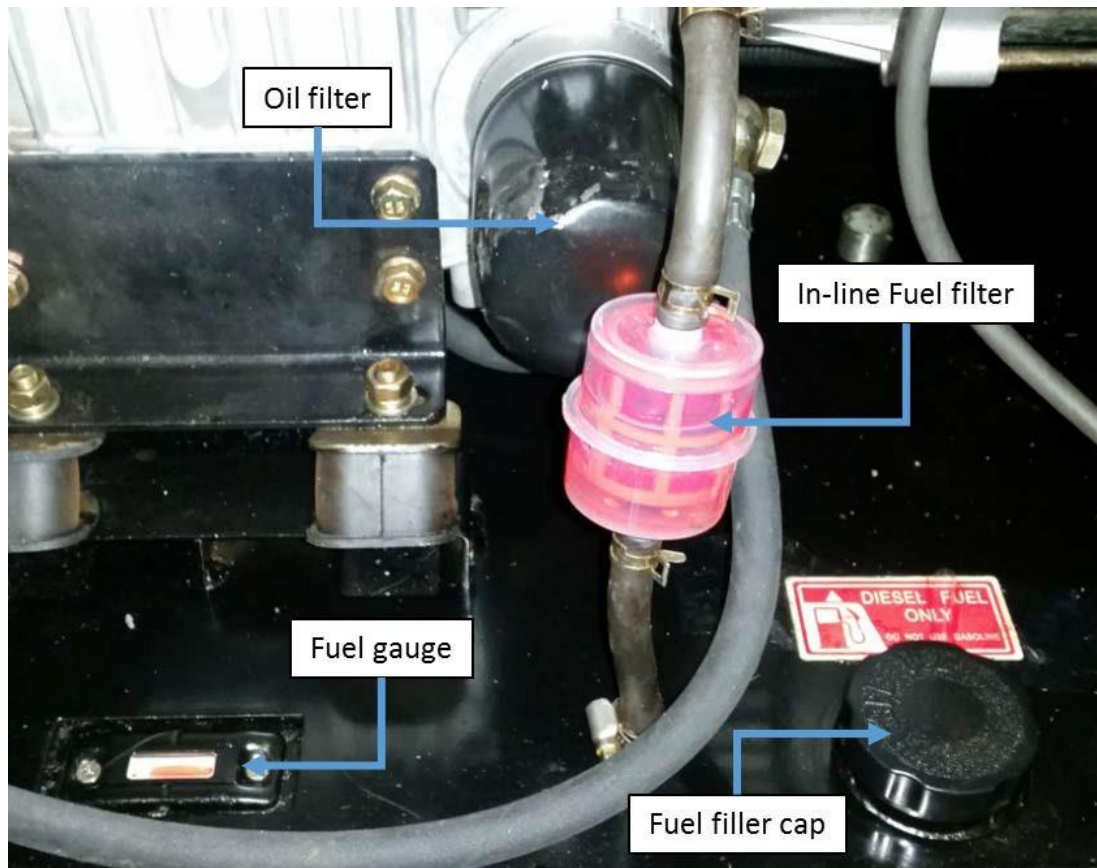

2.3. Battery - Sealed lead acid.



Corrosive

 **WARNING**

Batteries present a risk if they become damaged by the possible leaking of electrolyte. This electrolyte is an acid and can cause serious burn injuries. Care should be taken when working on or near them.

2.3.1. You should check that the battery is fully secured and that the connection are tight.

2.3.2. To access the battery remove the battery cover which is located under the main control panel. Undo the six retaining bolts and remove the cover. The battery should be fully secured using the anchor bar and two long retaining bolts.

2.3.3. The Red wire should be connected to the positive terminal and the Black wire to the negative terminal.

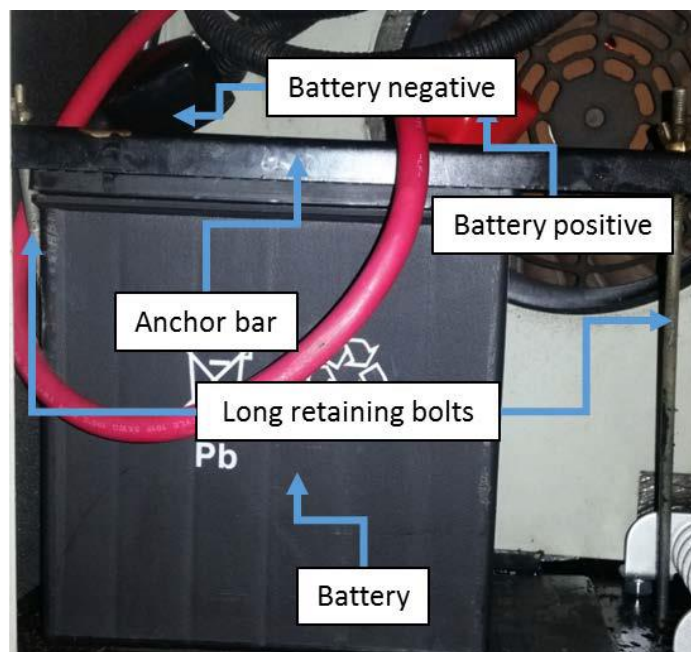

3. OPERATION

3.1. Starting the generator.

NOTE

Before starting you MUST disconnect all appliances. All circuit breakers are to be turned OFF. You MUST earth the generator before use.

3.1.1. Key start.

3.1.2. Turn the starter key clockwise to the ON position and allow the control panel to self-test, then turn the keyswitch against spring tension to START position until machine starts. DO NOT hold in START position for longer than 5 seconds. As soon as the machine starts release the key and allow it to return to the ON position. If the machine does not start wait 30 seconds before attempting to start again.



3.2. Control panel start.

3.2.1. Turn the starter key to the ON position and allow the control panel to self-test. Then press the Green start button, the machine will go through a self-start routine.

3.3. AC application.

3.3.1. Allow the machine to warm up for a minimum of five minutes.

3.3.2. Connect the appliance to the correct AC socket either 32A outlet or the 63A outlet. Then turn on the respective AC breaker.

3.4. Stopping the generator.

NOTE

Failure to carry out the following instructions can cause damage to the generator which will not be covered under warranty

3.4.1. Before stopping the generator YOU MUST firstly turn all appliances OFF, then turn the circuit breaker OFF then unplug the appliance from the machine. Move the start key to the OFF position or you can press the RED  stop button. Once stopped move the key switch to the OFF position

3.4.2. You MUST allow the machine to fully cool down before carrying out any maintenance work.

4. MAINTENANCE

4.1. Maintenance schedule.

⚠ NOTE

Proper maintenance is not only the basis of safe, economical and easy way of generator operation, but also helpful to reduce the air pollution.

⚠ WARNING

If these maintenance instructions are not followed properly, it may cause serious personal injury.

Item	Process	Maintenance period		
		Each use	After 1 st month or 20 hours	Every 3 months or 100 hours
Oil	Check	#		
	Replace		#	#
Air filter element	Check	#		
	Clean			#
Battery	Check	#		
Oil filter	Check		#	
	Replace			#
Fuel filter	Replace			#
Fuel pipes	Check	Check every 2 years - replace as required		

4.2. Oil change. DO NOT dispose of oil down any drains or directly onto the land. You should send your used oil to your local recycling centre.

It is best to drain the engine of all whilst the engine is still warm – DO NOT attempt to drain HOT engine oil.

4.2.1. Prepare a container to collect used oil and place it under the oil drain pipe.

4.2.2. Undo the oil filler cap.

4.2.3. Undo the nut of the end of the oil drain pipe and allow all of the used engine oil to drain into the oil container.

4.2.4. Once all oil has been drained you MUST securely replace the nut at the end of the oil drain pipe.

4.2.5. To access the oil filler cap remove the cover on the top of the machine. Use an oil filler jug and fill with oil SAE15W40 - From empty the machine can hold 2.25 litres of oil. Once full replace the filler cap securely.



4.3. Air filter.

⚠ NOTE

DO NOT operate the machine with the air filter missing – damage can occur which will not be covered under warranty

4.3.1. Access to the air filter – the air filter can be accessed from either side of the machine.

4.3.2. Release the side clips of the air filter and gently slide the filter assembly away from the filter housing.

4.3.3. Remove the fine foam filter and the two coarse filters. Wash them in soapy water rinse with fresh water allow to fully dry before re-fitting them.

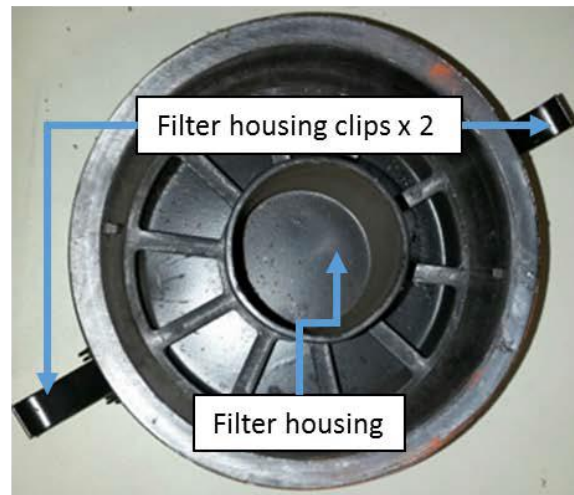
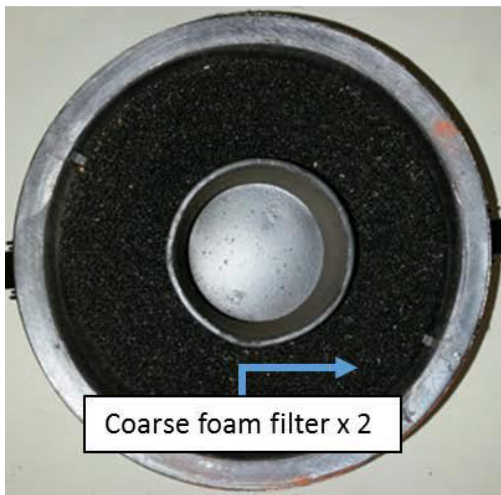
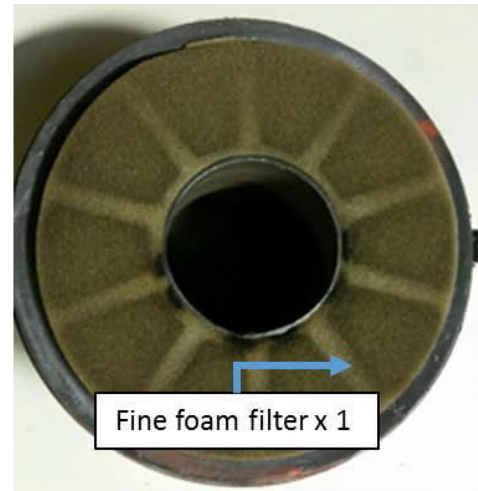
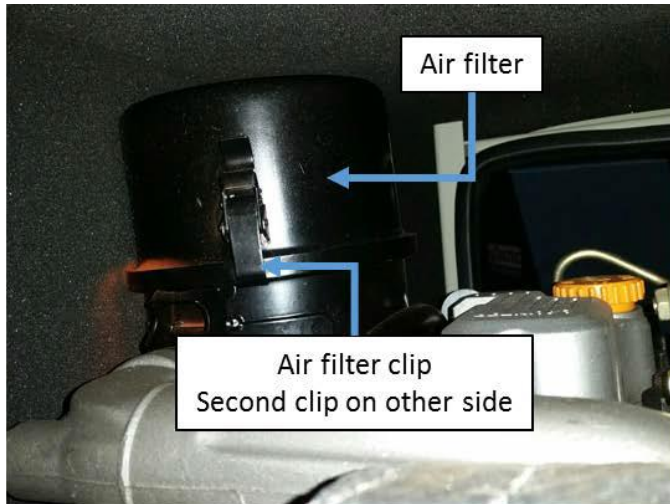

5. TROUBLESHOOTING

MACHINE WILL NOT START	CAUSE	REMEDY
Check the control system power	Poor connections	Check all connections including all plugs and sockets
	Low battery	Charge/replace the battery
Check fuel and oil	No Fuel	Fill with diesel fuel
	No Oil	Fill with oil
	Poor quality fuel	Replace old/stale fuel
Check cylinder compression	Piston ring worn or rings in wrong place	Contact your dealer
	Valve clearance is in-correct	
	Bolts of cylinder head are not tighten	
Check fuel supply system	Blocked fuel pipes	Clear blockages or replace as required
NO OUTPUT VOLATGE	CAUSE	REMEDY
Check circuit breaker	Circuit breaker not switched ON	Turn circuit breaker to ON position
	Circuit breaker is faulty	Replace the breaker
Check AVR	AVR is broken	
If no output after all other checks	Possible alternator failure	Contact your dealer

6. SPECIFICATIONS

DHY12500SE		
ENGINE	Engine model	HY290F
	Type	2 cylinder - Air cooled four stroke
	Speed - RPM	3000
	Maximum output – HP	20
	Starting method	Electric
	Oil sump capacity – L	2.25
GENERATOR	Type	Brushed AC single phase
	Frequency – hz	50
	Voltage – v	230
	Rated output – KW	10
	Max output – KW	11
	Power factor	1
	Fuel tank capacity – L	60
	Fuel consumption – g/kw.h	≤ 350
	Net weight – kg	295
	Overall size – L x W x H - mm	1175 x 695 x 925

7. WIRING DIAGRAM

ELECTRICAL WIRING DIAGRAM – SINGLE PHASE GENERATOR

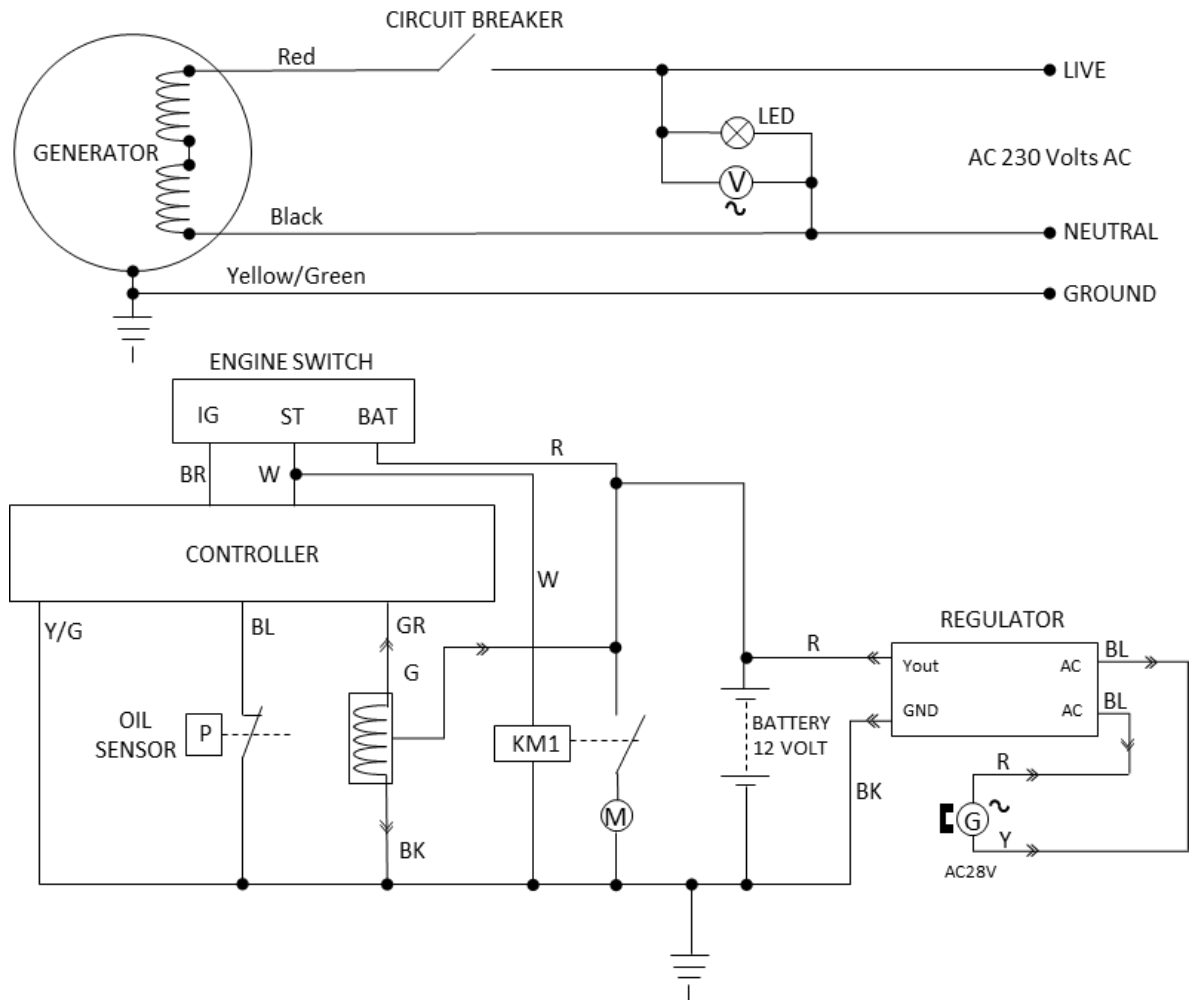

8. STORAGE & TRANSPORTATION

8.1. Storage.



DO NOT touch the exhaust or the engine during use or for at least two hours after use. To prevent fire hazard DO NOT move the generator into the storage area until it has fully cooled.

8.1.1. To keep generator in good condition, it will be necessary to store the generator in the correct way, the following steps are to protect the generator from rust and corrosion which would damage its performance and appearance. When correctly stored the generator will be easier to start.

8.2. Cleaning

8.2.1. If the generator has been stopped and is going to be cleaned before storage. You MUST allow the machine to cool for at least 2 hours. Clean all surfaces of the machine, any damaged parts should be treated to prevent rust from occurring.

8.3. Fuel.

8.3.1. Over time diesel fuel deteriorates so it should be removed before storing the machine. Failure to do so will result in the diesel fuel clogging up the fuel system which would be costly to rectify and would not be covered under warranty.

8.4. Storage area.

8.4.1. The storage area;

8.4.1.1. Should be dry, free of damp and have adequate ventilation.

8.4.1.2. Should be free of all sources of heat such as boilers, heaters etc.

8.4.1.3. Should be free of all sources of ignition such as naked flames, flammable materials etc.

8.4.1.4. The machine should be stored on a flat level surface and the wheels locked.

8.4.1.5. To prevent accidents or injury children and vulnerable persons should not be allowed access to the storage area.

8.5. Transport.

8.5.1. Before transporting the machine it should be allowed to cool for at least 2 hours.

8.5.2. All fuel should be removed prior to transportation.

8.5.3. The machine wheels must be locked and should be transported on a flat level surface to prevent oil leaks. It should also be strapped securely to prevent damage during transport.

9. PART LOCATIONS

9.1. Main unit.

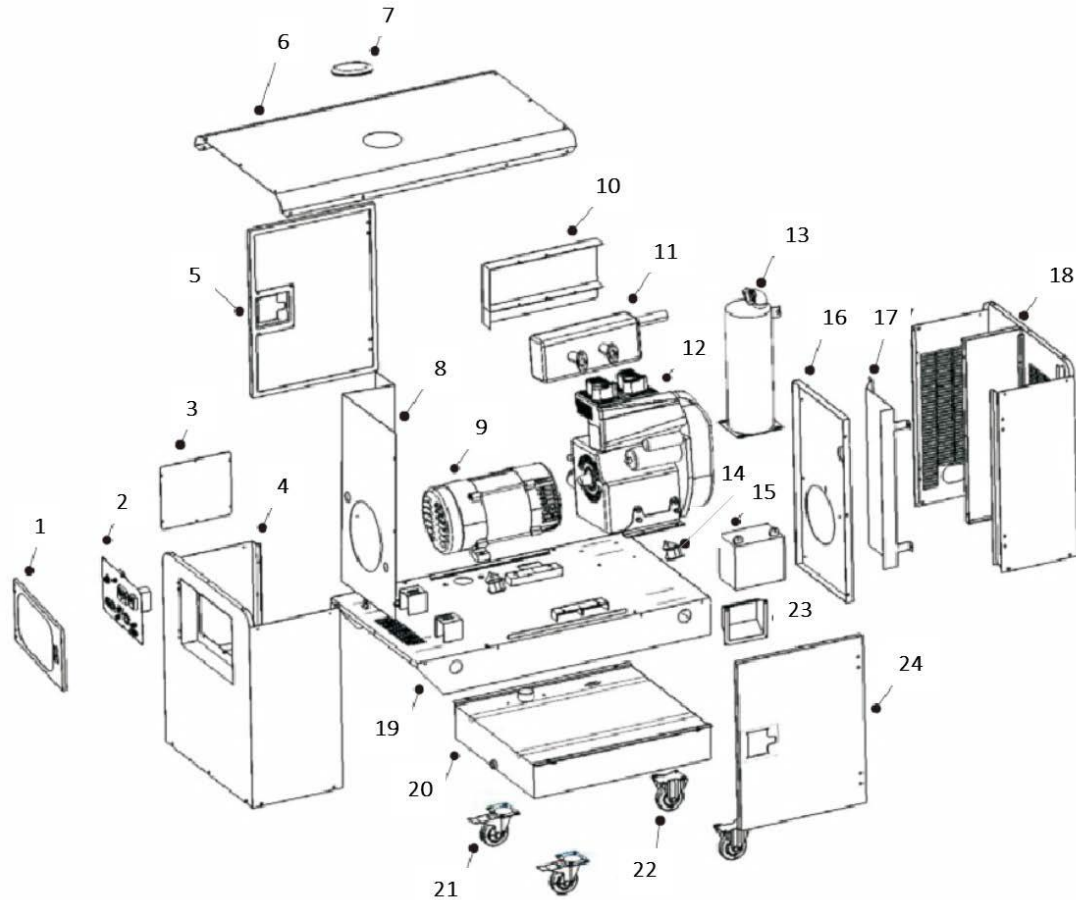

ITEM	DESCRIPTION	QTY	ITEM	DESCRIPTION	QTY
1	Control panel door	1	13	Exhaust assembly - 2	1
2	Control panel	1	14	Shock absorbers	6
3	Battery boards	1	15	Battery	1
4	Front cover	1	16	Inner cover	1
5	Left door	1	17	Air cover	1
6	Upper plate	1	18	Back cover	1
7	Rubber cover	1	19	Bottom seat	1
8	Alternator mounting board	1	20	Fuel tank	1
9	Alternator	1	21	Wheel	2
10	Exhaust heater insulation	1	22	Locking wheels	2
11	Exhaust assembly - 1	1	23	Locking door	1
12	Engine	1	24	Right door	1

9.2. Control panel layout.

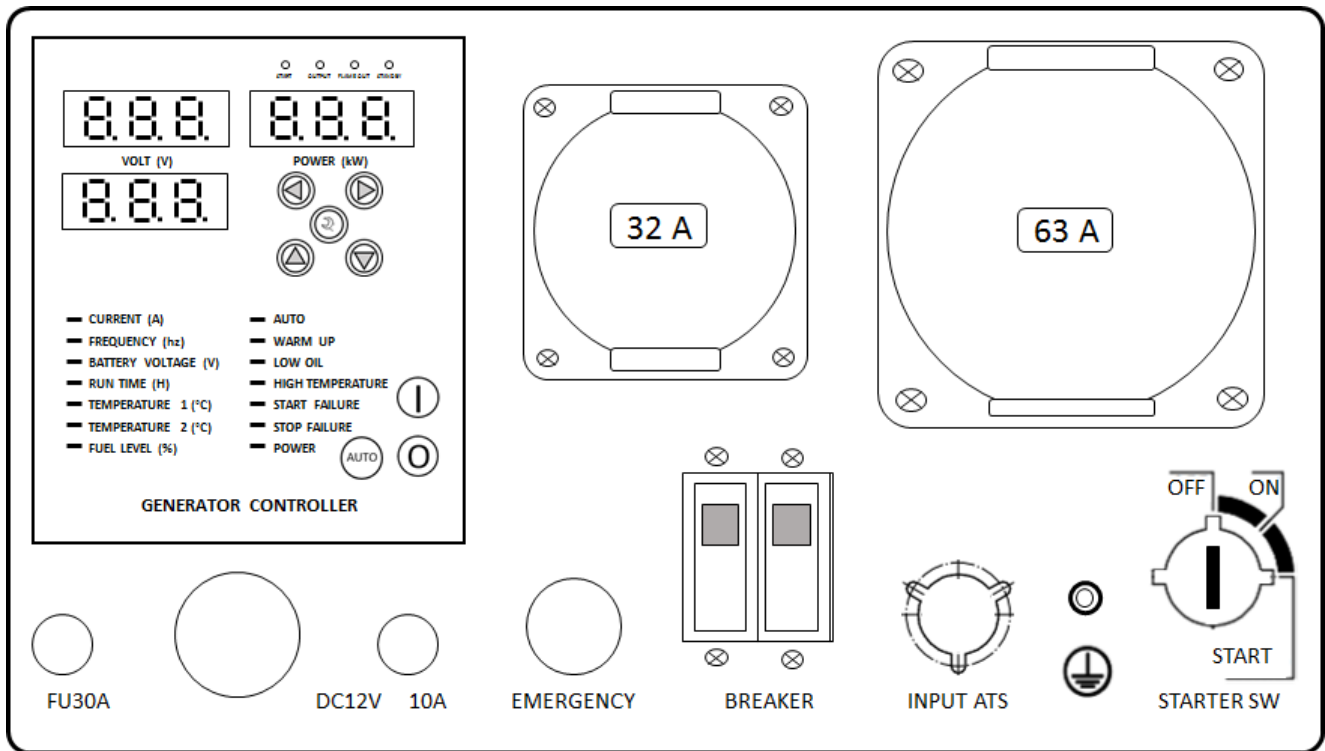

10. DECLARATIONS of CONFORMITY.

- 10.1. Genpower Ltd confirms that these Hyundai products conform to the following CE Directives;
2006/42/EC Machinery Directive.
2004/108/EC EMC Directive.
2000/14/EC Noise Emissions Directive.
97/68/EC NRMM Emissions Directive.
2006/95/EC Low Voltage Directive.

EC DECLARATION OF CONFORMITY

The undersigned, as authorised by: **Genpower Ltd**

Declares that the following equipment manufactured under licence by Hyundai Korea

Conforms to the Directive: -
2000/14/EC (as amended)

of the European Parliament and of the council on the approximation of the laws of the Member States relating to the noise emission in the environment by equipment for use outdoors.

Equipment Category: **Generator**
Product Name/Model: **Hyundai DHY12500SE**
Type/Serial No: **Diesel Generator**
Net installed power: **10 kW**
The technical documentation is kept by: **Roland Llewellyn, Genpower Ltd,
Isaac Way, Pembroke Dock,
Pembrokeshire, SA72 4RW.**

The conformity assessment procedure followed was in according with annex VI of the Directive.

Testing laboratory: **Jiangsu TÜV Product Service GmbH,
Zertifizierstelle,
Ridlerstraße 65
80339 München.
Germany.**
Test report n°: **64.664.12.016.01**
Measured Sound Power Level: **96 dB(A)**
Guaranteed Sound Power Level: **96 dB(A)**

A copy of this certificate has been submitted to the European Commission and to EU Member State United Kingdom.

Place of Declaration: **Pembroke Dock, SA72 4RW**
Date: **22nd November 2016**
Signed by: **Roland Llewellyn**
Position in Company: **Director**
Name and address of manufacturer or Authorised representative:



**Genpower Ltd,
Isaac Way, Pembroke Dock,
Pembrokeshire, SA72 4RW.**

11. RECYCLING & PRODUCT DISPOSAL

11.1. We do not offer a takeback scheme for the recovery of Waste Electrical Electronic Equipment (WEEE) & Batteries instead the responsibility to dispose of WEEE and or Batteries is passed onto you by us. So when it becomes necessary to dispose of your machine you must take it to your local Civic Amenity Site. For further information please contact your Local Authority for disposal advice.

11.2. You MUST make sure that all unused oil and fuel is disposed of correctly either beforehand or at your local Civic Amenity Site. Under NO circumstance must any oil and fuel be put down any drains.

11.3. Waste Electrical Electronic Equipment (WEEE) recycling.

11.3.1. Certain products contain WEEE waste which should not be disposed of in your domestic waste.



11.3.2. You MUST recycle WEEE in accordance with your local authority or recycling centre.

11.4. Battery recycling, certain products contain batteries which should not be disposed of in your domestic waste.



11.4.1. You MUST recycle batteries in accordance with your local authority or recycling centre.

11.5. Unwanted packaging materials should be sorted and taken to a recycling centre so it can be disposed of in a manner which is compatible with the environment.

11.6. The following symbol means that you should 'Reduce – Reuse – Recycle'.



11.7. We are a Member of the VALPAK National Compliance scheme and our registration number is RM08660

11.8. For further information about disposal please contact your Local Authority.

11.9. You can also get more advice and guidance about recycling at the following website <http://www.recycle-more.co.uk>

11.10. Should you pass this product onto another user either sold or loaned you MUST pass on this user manual. This will make sure that all other users can use and maintain the machine safely.



12. CONTACT DETAILS

POSTAL ADDRESS

Genpower Ltd, Isaac Way, London Road, Pembroke Dock, Pembrokeshire, SA72 4RW. UK.

TELEPHONE

+44 (0) 1646 687880

FAX

+44 (0) 1646 686198

TECHNICAL E-MAIL

service@genpower.co.uk

WEBSITE

www.hyundaipowerequipment.co.uk

13. MANUAL UPDATES

13.1. Our manuals are constantly being reviewed and updated. Should you find an error, omission or something you find unclear please contact your dealer for assistance. E&OE.

13.2. Our latest manuals are also placed online.

13.3. We reserve the right to make any modifications without prior notice whenever necessary.

14. WARRANTY

14.1. To register your product for the manufacturer's warranty, please visit:

<https://hyundaipowerequipment.co.uk/warranty>

HYUNDAI
POWER PRODUCTS

For Inquiries, Please Contact:

GENPOWER LTD
Isaac Way, London Road
Pembroke Dock, UNITED KINGDOM, SA72 4RW
T: +44 (0) 1646 687 880 F: +44 (0) 1646 686 198
E: info@hyundaipowerequipment.co.uk
www.hyundaipowerequipment.co.uk